

Style 231S Non-Restrained Flexible Expansion Coupling

Victaulic Bolted Split-Sleeve Products (VBSP) Style 231S stainless steel expansion couplings (formerly Depend-O-Lok FxE) provide a non-restrained, flexible pipe joint that is designed to accommodate axial pipe movement at the joint. The Style 231S coupling satisfies the requirements set forth by the AWWA C227 Standard for Restrained and Non-Restrained Couplings for Plain-End Pipe.

This style of coupling is typically used in exposed pipe applications for field joint connections where axial pipe movement due to thermal expansion or contraction of the pipe line is a factor. Although Style 231S expansion couplings provide for a flexible joint and therefore do not prevent angular pipe movement, these couplings are not designed to accommodate static or dynamic angular deflection at the joint. Style 231S couplings should be used to accommodate axial pipe movement only. The Style 231S couplings can allow for up to 4/100 mm of axial pipe movement at the joint and therefore assist in avoiding the accumulation of thermal stresses due to changes in pipe length. For these couplings to function properly, the pipe movement must be axially directed to the joint through the proper use of pipe supports, anchors and/or guides. External restraints must be installed to ensure the coupling does not exceed published values for expansion capabilities. Typical applications include water and wastewater treatment pipeline and other piping applications where changes in pipe temperature result in axial pipe movement that requires the use of an expansion joint to avoid thermal stresses.

The dual-arched mechanical coupling body houses o-ring gaskets that provide the radial seal around the circumference of the pipe, while the sealing plate provides for the axial seal across the coupling body and pipe joint. The Style 231S coupling incorporates a restraint ring(s) welded to one pipe end (furnished with the coupling) that keep the coupling in place on the "fixed" side of the joint, while allowing the pipe to move axially within the coupling on the "expansion" side of the joint. The coupling housing is designed to accommodate hoop stress to meet system pressure requirements while maintaining a leak-proof joint seal. The expansion coupling also performs at negative pipe pressures up to full vacuum since the o-ring gasket is not pressure responsive and therefore does not require internal pipe pressure to assist with the seal. The arched cross-sectional shape of the coupling provides for a high section modulus to resist forces encountered during negative pressure (submerged) or vacuum service.

Style 231S couplings are available in standard nominal sizes from 3 – 96"/80 – 2400 mm with larger sizes available based on design and application requirements. The Style 231S coupling can accommodate operating pressures up to 300 psi/2065 kPa (with higher pressure available) depending on the actual pipe diameter and wall thickness. For pressures and sizes not shown in the dimension and performance tables contact Victaulic for information on our engineered products.

All flexible mechanical couplings should be properly supported to minimize or eliminate undesirable loads at the joint. Pipe support requirements are defined within the Victaulic Application Guidelines document. Please see publication 26.20. For differential settlement conditions, Victaulic recommends, at minimum, the use of two Style 233S couplings.

For proper closure tool selection see column marked Tool Type on pages 6-9.



3 – 96"/80 – 2400mm

JOB/OWNER

System No. _____

Location _____

CONTRACTOR

Submitted By _____

Date _____

ENGINEER

Spec Sect _____ Para _____

Approved _____

Date _____

www.victaulic.com

VICTAULIC IS A REGISTERED TRADEMARK OF VICTAULIC COMPANY. © 2013 VICTAULIC COMPANY. ALL RIGHTS RESERVED.

REV_J



60.04_1

Style 231S Non-Restrained Flexible Expansion Coupling

PRODUCT GUIDE

Product Style Guide			
Submittal Number	Style Number	Coupling/Body Material	Application
60.01	230	Carbon Steel	Non-Restrained Coupling
60.02	230S	Stainless Steel	Non-Restrained Coupling
60.03	231	Carbon Steel	Expansion Coupling
60.04	231S	Stainless Steel	Expansion Coupling
60.05	232	Carbon Steel	Restrained Coupling
60.06	232S	Stainless Steel	Restrained Coupling
60.07	233	Carbon Steel	Restrained Coupling For Dynamic Joint Deflection
60.08	233S	Stainless Steel	Restrained Coupling For Dynamic Joint Deflection
60.09	234	Carbon Steel	Restrained Single-Gasket Coupling
60.10	234S	Stainless Steel	Restrained Single-Gasket Coupling

SEGMENTED COUPLINGS

The Style 231S dimension tables list the minimum number of coupling housing segments for a particular pipe size. For special applications, expansion couplings are available in two (or more) segments to allow for installation of the coupling over an existing pipe joint or to facilitate ease of handling for larger size couplings. The o-ring gaskets (except Silicone) can be furnished "split" to allow for field bonding when an existing pipe joint configuration does not allow for installation of a complete o-ring onto the pipe end.

BODY TYPE

Cross-Sections

NOTE: Body type is not optional and will be determined by system requirements.



Type 1 coupling is the basic split sleeve design for expansion services and is generally used for smaller diameter, low pressure applications.

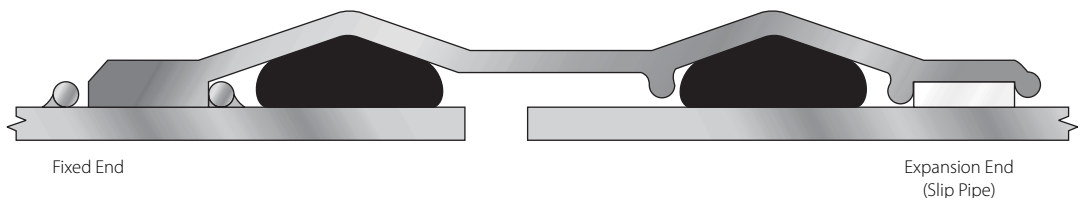

Type 2 coupling is a shouldered coupling. This is a heavy duty coupling to accommodate higher pressures for certain pipe diameters. The steel shoulder welded to the edge of one side of the coupling body provides additional cross-sectional stiffness and provides the mechanism for holding the coupling in place between the restraint rings attached to the pipe on the fixed side of the joint. The Teflon® shoulder provides a smooth surface at the area of contact between the coupling housing and pipe to allow for unimpeded pipe movement.

Style 231S Non-Restrained Flexible Expansion Coupling

COUPLING COMPONENTS

1. Body – Dual arch cross-section.

2. Shoulders (Type 2 only)

Fixed Side – Rectangular steel bar located at coupling body edge provides additional stiffness, allows for larger o-ring gasket and provides vertical bearing surface for restraint ring.

Expansion Side – Utilizes Teflon® material to provide for a smooth sliding surface in order to accommodate larger expansion values afforded by the Style 231S Type 2 coupling.

3. Closure Plates – Low profile bolt pads for installation and tightening of coupling; gap between plates of installed coupling allows for field flexibility.

4. Sealing Plate – Provides axial seal across the coupling body and pipe joint.

5. O-ring Gaskets – Provide circumferential seal.

6. Fasteners

Studs – High Strength Threaded Rod

Nuts – Heavy Hex Nuts

Washers – SAE small pattern flat washers

7. Restraint Rings – Used to maintain coupling position on the "fixed" end of the pipe.

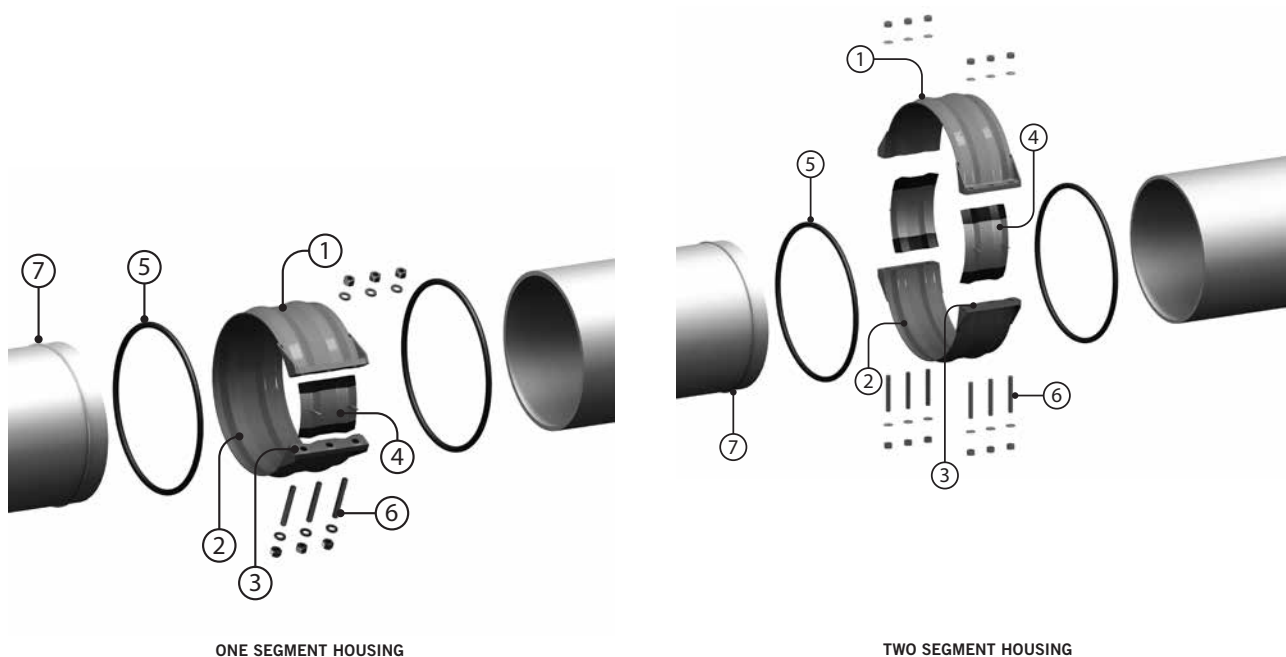

Style 231S Non-Restrained Flexible Expansion Coupling

MATERIAL SPECIFICATIONS

Body

Stainless Steel conforming to ASTM A240 316/316L

Shoulders (Type 2)

Stainless Steel conforming to ASTM A240 316L (Fixed Side)
Teflon* - PTFE commercial grade (Expansion Side)

Closure Plates

Stainless Steel conforming to 316L

Sealing Plate

Stainless Steel conforming to ASTM A240 316L

O-ring Gaskets

Standard (Specify choice on order):

EPDM -30°F to +230°F/-34°C to +110°C

Cold and hot water within allowable temperature range; dilute acids; excellent resistance to the deteriorative effects of ozone, oxygen, heat and most chemicals not involving hydrocarbons.
NOT RECOMMENDED FOR PETROLEUM SERVICES.

- **Silicone** -30°F to +350°F/-34°C to +177°C

Dry, hot air applications; excellent resistance to many chemicals.
NOT RECOMMENDED FOR HOT WATER OR STEAM APPLICATIONS.

- **Isoprene** -40°F to +160°F/-40°C to +71°C

Water; salt water; sewage; good resistance to oxygen and dilute acids

Services listed are general service recommendations only. Refer to a chemical elastomer guide for specific applications and suitability of gasket material for services that are not listed.

Optional gasket (specify choice on order):

- **Nitrile** -20°F to +180°F/-28°C to +82°C

Water; petroleum products, vegetable and mineral oils; air with oil vapors within allowable temperature range; good resistance to hydrocarbons; acids and bases.

- **Fluoroelastomer** +20°F to +300°F/-7°C to +149°C

Outstanding resistance to heat and most chemicals.

- **Neoprene** -30°F to +180°F/-34°C to +82°C

Water and wastewater; good resistance to ozone, effects of UV and some oils.

Restraint Rings

Stainless Steel conforming to ASTM A276 316L

Permanent Fasteners

Studs - Stainless Steel conforming to ASTM A193 Grade B8M 316 Class 2

Nuts - Heavy hex nuts

Stainless Steel conforming to ASTM A194 Grade 8M 316

Washers - Stainless Steel Type 316 SAE pattern

Installation Fasteners (for installation purposes only, are supplied with Type 2 couplings)

Studs - Carbon Steel conforming to ASTM A193 Grade B7 zinc plated

Nuts - Heavy hex nuts

Carbon Steel conforming to ASTM A194 Grade 2H zinc plated

Washers - Carbon Steel SAE small pattern flat washers conforming to ASTM F436 SAE pattern zinc plated

* Teflon is a registered trademark of DuPont Corporation.

Style 231S Non-Restrained Flexible Expansion Coupling

PIPE END DIMENSIONAL TOLERANCE AND OVALITY

For specific pipe diameter tolerances, pipe ovality (roundness) requirements and minimum/maximum pipe diameter allowance, refer to the tables included in the Installation Manuals (below) and 26.20 Application Guidelines.

I-231.T1S1 - Styles 231/231S Expansion Coupling (Type 1, One-Segment)

I-231.T1S2 - Styles 231/231S Expansion Coupling (Type 1, Two-Segments)

I-231.T2S1 - Styles 231/231S Expansion Coupling (Type 2, One-Segment)

I-231.T2S2 - Styles 231/231S Expansion Coupling (Type 2, Two-Segments)

Style 231S Non-Restrained Flexible Expansion Coupling

DIMENSIONS

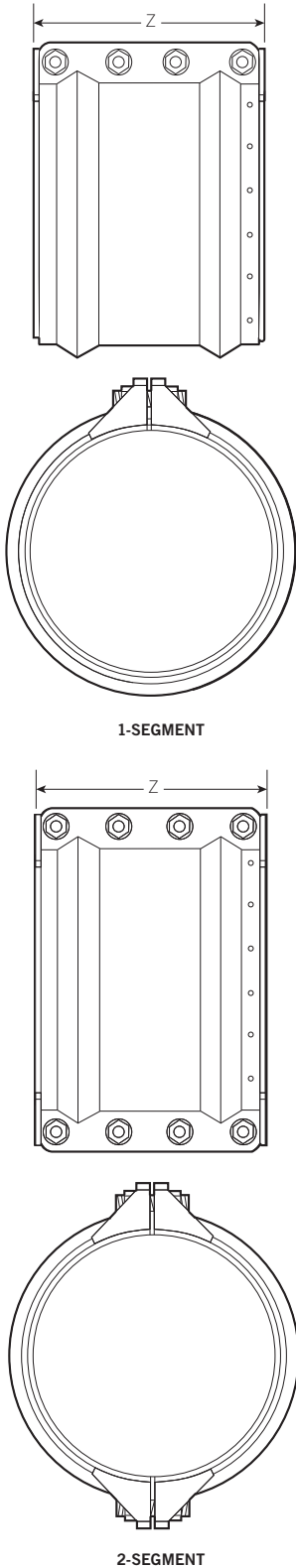

(1) Nominal Pipe Size In./mm	(2) Actual Pipe O.D. Range In./mm	(3) Maximum Working Pressure psi/kPa	Coupling Dimensions		(4) Min. No. of Coupling Segments	No. of Fasteners - Fastener Dimensions Dia. x Length In. x In.	(5) Approximate Weight Each Lbs./Kg.	Body Type	(6) Tool Type
			Body Thickness In.	Width (Z) In./mm					
3 80	2.88 - 3.50 73.2 - 88.9	300 2065	14 ga.	5.25 133.4	1	3 - 1/2 x 3 1/4	5.0 2.3	1	A
4 100	3.63 - 4.88 92.2 - 123.9	300 2065	14 ga.	5.25 133.4	1	3 - 1/2 x 3 1/4	5.0 2.3	1	A
6 150	5.00 - 6.88 127.0-174.8	300 2065	12 ga.	8.00 203.2	1	3 - 1/2 x 3 1/4	12.0 5.4	1	A
8 200	7.00 - 8.88 177.8 - 225.6	200 1375	11 ga.	10.00 254.0	1	3 - 5/8 x 5	21.0 9.5	1	B,C
10 250	9.00 - 10.88 228.6 - 276.4	200 1375	10 ga.	10.00 254.0	1	3 - 5/8 x 5	24.0 10.9	1	B,C
12 300	11.00 - 12.88 279.4 - 327.2	200 1375	10 ga.	10.00 254.0	1	3 - 5/8 x 5	28.0 12.7	1	B,C
14 350	13.00 - 14.88 330.2 - 378.0	200 1375	10 ga.	10.00 254.0	1	3 - 5/8 x 5	31.0 14.1	1	B,C
16 400	15.00 - 16.88 381.0 - 428.8	200 1375	3/16	10.00 254.0	1	3 - 3/4 x 6	48.0 21.8	1	B,C
			1/4	14.38 365.3	1	4 - 3/4 x 6	102.0 46.3	2	C
			1/4	16.38 416.1	1	5 - 3/4 x 6	115.0 52.2	2	C
18 450	17.00 - 18.88 431.8 - 479.6	250 1725	3/16	10.00 254.0	1	3 - 3/4 x 6	52.0 23.6	1	B,C
			1/4	14.38 365.3	1	4 - 3/4 x 6	111.0 50.3	2	C
			1/4	16.38 416.1	1	5 - 3/4 x 6	125.0 56.7	2	C
20 500	19.00 - 21.88 482.6 - 555.8	250 1725	3/16	10.00 254.0	1	3 - 3/4 x 6	136.0 61.7	2	C
			1/4	14.38 365.3	1	4 - 3/4 x 6	120.0 54.4	2	C
			1/4	16.38 416.1	1	5 - 3/4 x 6	135.0 61.2	2	C
24 600	22.00 - 26.88 558.8 - 682.8	150 1035	3/16	10.00 254.0	1	3 - 3/4 x 6	147.0 66.7	2	C
			1/4	14.38 365.3	1	4 - 3/4 x 6	140.0 63.5	2	C
			1/4	16.38 416.1	1	5 - 3/4 x 6	156.0 70.8	2	C
		300 2065	1/4	18.38 466.9	1	5 - 3/4 x 6	171.0 77.6	2	C
			3/8	14.38 365.3	2	8 - 7/8 x 8	323.0 146.5	2	C
			3/8	16.38 416.1	2	10 - 7/8 x 8	368.0 166.9	2	C
3/8	18.38 466.9	2	10 - 7/8 x 8	402.0 182.3	2	C			

(1) Couplings must be used on pipe with a minimum wall thickness that meets the requirements of AWWA C220 for stainless steel pipe.
 (2) For actual pipe O.D. round down to the nearest 1/8" to determine proper coupling size required.
 (3) For allowable test or transient pressure, the maximum working pressure may be increased to 1 1/2 times the values shown.
 (4) 1-segment couplings may be available as 2-segment couplings to allow for in-place pipe installations. Contact Victaulic for details.
 (5) Coupling weights are based on nominal pipe diameter and include all accessories. Weight may vary based on actual size of pipe.
 (6) Closure Tool Recommendations: *
 A= CTM-01 Small Manual Closure Tool
 B= CTM-02 Large Manual Closure Tool
 C= CTH-01 10-Ton Hydraulic Closure Tool
 *For more details on closure tools see page 17.
 Note: The data in this table only applies when stainless steel couplings are being used on stainless steel pipe.

Style 231S Non-Restrained Flexible Expansion Coupling

DIMENSIONS

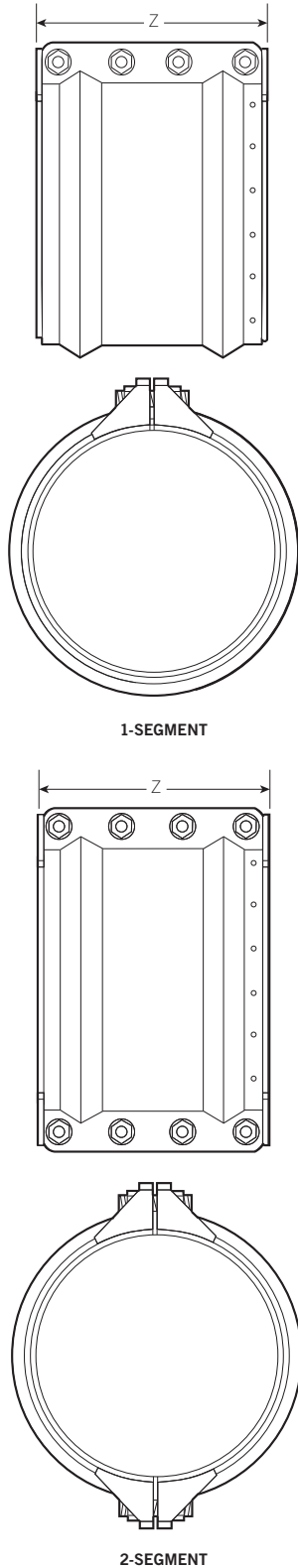

(1) Nominal Pipe Size In./mm	(2) Actual Pipe O.D. Range In./mm	(3) Maximum Working Pressure psi/kPa	Coupling Dimensions		(4) Min. No. of Coupling Segments	No. of Fasteners - Fastener Dimensions Dia. x Length In. x In.	(5) Approximate Weight Each Lbs/Kg.	Body Type	(6) Tool Type
			Body Thickness In.	Width (Z) In./mm					
30 750	27.00 - 32.88 685.8 - 835.2	100 690	1/4	14.38 365.3	1	4 - 3/4 x 6	169.0 76.7	2	C
			1/4	16.38 416.1	1	5 - 3/4 x 6	186.0 84.4	2	C
			1/4	18.38 466.9	1	5 - 3/4 x 6	204.0 92.5	2	C
		300 2065	3/8	14.38 365.3	2	8 - 7/8 x 8	373.0 169.2	2	C
			3/8	16.38 416.1	2	10 - 7/8 x 8	425.0 192.8	2	C
			3/8	18.38 466.9	2	10 - 7/8 x 8	464.0 210.5	2	C
36 900	33.00 - 38.88 838.2 - 987.6	75 515	1/4	14.38 365.3	1	4 - 3/4 x 6	196.0 88.9	2	C
			1/4	16.38 416.1	1	5 - 3/4 x 6	216.0 98.0	2	C
			1/4	18.38 466.9	1	5 - 3/4 x 6	237.0 107.5	2	C
		250 1725	3/8	14.38 365.3	2	8 - 7/8 x 8	425.0 192.8	2	C
			3/8	16.38 416.1	2	10 - 7/8 x 8	483.0 219.1	2	C
			3/8	18.38 466.9	2	10 - 7/8 x 8	528.0 239.5	2	C
42 1050	39.00 - 44.88 990.6 - 1140.0	50 345	1/4	14.38 365.3	1	4 - 3/4 x 6	224.0 101.6	2	C
			1/4	16.38 416.1	1	5 - 3/4 x 6	246.0 111.6	2	C
			1/4	18.38 466.9	1	5 - 3/4 x 6	270.0 122.5	2	C
		200 1375	3/8	14.38 365.3	2	8 - 7/8 x 8	475.0 215.5	2	C
			3/8	16.38 416.1	2	10 - 7/8 x 8	539.0 244.5	2	C
			3/8	18.38 466.9	2	10 - 7/8 x 8	591.0 268.1	2	C
48 1200	45.00 - 50.88 1143.0 - 1292.4	50 345	1/4	14.38 365.3	1	4 - 3/4 x 6	251.0 113.9	2	C
			1/4	16.38 416.1	1	5 - 3/4 x 6	277.0 125.6	2	C
			1/4	18.38 466.9	1	5 - 3/4 x 6	303.0 137.4	2	C
		200 1375	3/8	14.38 365.3	2	8 - 7/8 x 8	526.0 238.6	2	C
			3/8	16.38 416.1	2	10 - 7/8 x 8	596.0 270.3	2	C
			3/8	18.38 466.9	2	10 - 7/8 x 8	655.0 297.1	2	C

(1) Couplings must be used on pipe with a minimum wall thickness that meets the requirements of AWWA C220 for stainless steel pipe.
 (2) For actual pipe O.D. round down to the nearest 1/8" to determine proper coupling size required.
 (3) For allowable test or transient pressure, the maximum working pressure may be increased to 1 1/2 times the values shown.
 (4) 1-segment couplings may be available as 2-segment couplings to allow for in-place pipe installations. Contact Victaulic for details.
 (5) Coupling weights are based on nominal pipe diameter and include all accessories. Weight may vary based on actual size of pipe.
 (6) Closure Tool Recommendations:
 A= CTM-01 Small Manual Closure Tool
 B= CTM-02 Large Manual Closure Tool
 C= CTH-01 10-Ton Hydraulic Closure Tool
 *For more details on closure tools see page 17.
 Note: The data in this table only applies when stainless steel couplings are being used on stainless steel pipe.

Style 231S Non-Restrained Flexible Expansion Coupling

DIMENSIONS

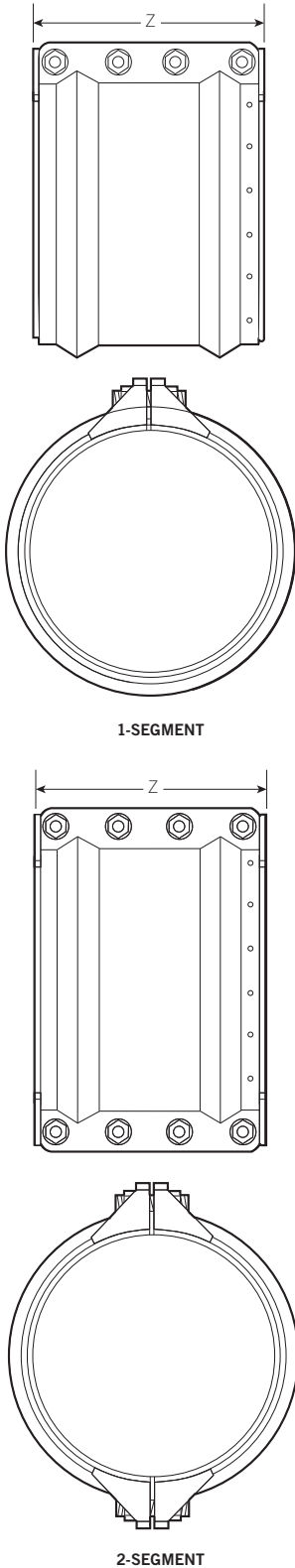

(1) Nominal Pipe Size In./mm	(2) Actual Pipe Range In./mm	(3) Maximum Working Pressure psi/kPa	Coupling Dimensions		(4) Min. No. of Coupling Segments	No. of Fasteners - Fastener Dimensions Dia. x Length In. x In.	(5) Approximate Weight Each Lbs/Kg.	Body Type	(6) Tool Type
			Body Thickness In.	Width (Z) In./mm					
54 1350	51.00 - 56.88 1295.4 - 1444.8	25 170	1/4	14.38 365.3	1	4 - 7/8 x 8	306.0 138.8	2	C
			1/4	16.38 416.1	1	5 - 7/8 x 8	341.0 154.7	2	C
			1/4	18.38 466.9	1	5 - 7/8 x 8	371.0 168.3	2	C
		175 1200	3/8	14.38 365.3	2	8 - 7/8 x 8	563.0 255.4	2	C
			3/8	16.38 416.1	2	10 - 7/8 x 8	638.0 289.4	2	C
			3/8	18.38 466.9	2	10 - 7/8 x 8	702.0 318.4	2	C
60 1500	57.00 - 62.88 1447.8 - 1597.2	25 170	1/4	14.38 365.3	2	8 - 7/8 x 8	390.0 176.9	2	C
			1/4	16.38 416.1	2	10 - 7/8 x 8	438.0 198.7	2	C
			1/4	18.38 466.9	2	10 - 7/8 x 8	476.0 215.9	2	C
		150 1035	3/8	14.38 365.3	2	8 - 7/8 x 8	615.0 279.0	2	C
			3/8	16.38 416.1	2	10 - 7/8 x 8	696.0 315.7	2	C
			3/8	18.38 466.9	2	10 - 7/8 x 8	765.0 346.9	2	C
66 1650	63.00 - 68.88 1600.2 - 1749.6	150 1035	3/8	14.38 365.3	2	8 - 7/8 x 8	652.0 295.7	2	C
			3/8	16.38 416.1	2	10 - 7/8 x 8	739.0 335.2	2	C
			3/8	18.38 466.9	2	10 - 7/8 x 8	812.0 368.3	2	C
72 1800	69.00 - 74.88 1752.6 - 1902.0	125 860	3/8	14.38 365.3	2	8 - 7/8 x 8	703.0 318.9	2	C
			3/8	16.38 416.1	2	10 - 7/8 x 8	795.0 360.6	2	C
			3/8	18.38 466.9	2	10 - 7/8 x 8	875.0 396.8	2	C
78 1950	75.00 - 80.88 1905.0 - 2054.4	125 860	3/8	14.38 365.3	2	8 - 7/8 x 8	742.0 336.6	2	C
			3/8	16.38 416.1	2	10 - 7/8 x 8	838.0 380.1	2	C
			3/8	18.38 466.9	2	10 - 7/8 x 8	922.0 418.2	2	C
84 2100	81.00 - 86.88 2057.4 - 2206.8	100 690	3/8	14.38 365.3	2	8 - 7/8 x 8	792.0 359.2	2	C
			3/8	16.38 416.1	2	10 - 7/8 x 8	911.0 413.2	2	C
			3/8	18.38 466.9	2	10 - 7/8 x 8	1001.0 454.0	2	C
90 2250	87.00 - 92.88 2209.8 - 2359.2	100 690	3/8	14.38 365.3	2	8 - 7/8 x 8	830.0 376.5	2	C
			3/8	16.38 416.1	2	10 - 7/8 x 8	937.0 425.0	2	C
			3/8	18.38 466.9	2	10 - 7/8 x 8	1032.0 468.1	2	C

(1) Couplings must be used on pipe with a minimum wall thickness that meets the requirements of AWWA C220 for stainless steel pipe.
 (2) For actual pipe O.D. round down to the nearest 1/8" to determine proper coupling size required.
 (3) For allowable test or transient pressure, the maximum working pressure may be increased to 1 1/2 times the values shown.
 (4) 1-segment couplings may be available as 2-segment couplings to allow for in-place pipe installations. Contact Victaulic for details.
 (5) Coupling weights are based on nominal pipe diameter and include all accessories. Weight may vary based on actual size of pipe.
 (6) Closure Tool Recommendations:
 A= CTM-01 Small Manual Closure Tool B= CTM-02 Large Manual Closure Tool C= CTH-01 10-Ton Hydraulic Closure Tool
 *For more details on closure tools see page 17.
 Note: The data in this table only applies when stainless steel couplings are being used on stainless steel pipe.

Style 231S Non-Restrained Flexible Expansion Coupling

DIMENSIONS

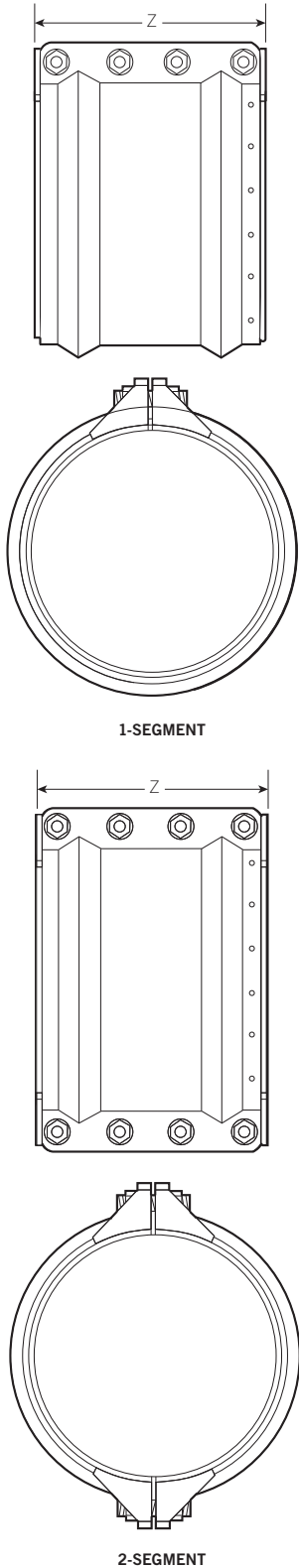

(1) Nominal Pipe Size In./mm	(2) Actual Pipe O.D. Range In./mm	(3) Maximum Working Pressure psi/kPa	Coupling Dimensions		(4) Min. No. of Coupling Segments	No. of Fasteners - Fastener Dimensions Dia. x Length In. x In.	(5) Approximate Weight Each Lbs/Kg.	Body Type	(6) Tool Type
			Body Thickness In.	Width (Z) In./mm					
96 2400	93.00 - 102.00 2362.2 - 2590.8	100 690	3/8	14.38 365.3	2	8 - 7/8 x 8	893.0 405.1	2	C
			3/8	16.38 416.1	2	10 - 7/8 x 8	1008.0 457.2	2	C
			3/8	18.38 466.9	2	10 - 7/8 x 8	1111.0 503.9	2	C

- (1) Couplings must be used on pipe with a minimum wall thickness that meets the requirements of AWWA C220 for stainless steel pipe.
 - (2) For actual pipe O.D. round down to the nearest 1/8" to determine proper coupling size required.
 - (3) For allowable test or transient pressure, the maximum working pressure may be increased to 1 1/2 times the values shown.
 - (4) 1-segment couplings may be available as 2-segment couplings to allow for in-place pipe installations. Contact Victaulic for details.
 - (5) Coupling weights are based on nominal pipe diameter and include all accessories. Weight may vary based on actual size of pipe.
 - (6) Closure Tool Recommendations:
 - A= CTM-01 Small Manual Closure Tool
 - B= CTM-02 Large Manual Closure Tool
 - C= CTH-01 10-Ton Hydraulic Closure Tool
- *For more details on closure tools see page 17.
 Note: The data in this table only applies when stainless steel couplings are being used on stainless steel pipe.

Style 231S Non-Restrained Flexible Expansion Coupling

PERFORMANCE

Nominal Pipe Size In./mm	(1)			Body Type	Width (Z) In./mm	(2) Pipe End Separation Min - Max In./mm	Max. Allowable Axial Pipe Movement In./mm	
	Maximum Working Pressure psi/kPa Carbon Steel	Maximum Working Pressure psi/kPa Stainless Steel	Maximum Working Pressure psi/kPa Ductile Iron					
3 80	300 2065	300 2065	N/R	1	5.25 133.4	0 - 0.75 0 - 19.1	0.75 19.1	
4 100	300 2065	300 2065	N/R	1	5.25 133.4	0 - 0.75 0 - 19.1	0.75 19.1	
6 150	300 2065	300 2065	N/R	1	8.00 203.2	0 - 1.25 0 - 31.8	1.25 31.8	
8 200	200 1375	200 1375	N/R	1	10.00 254.0	0 - 1.50 0 - 38.1	1.5 38.1	
10 250	200 1375	200 1375	N/R	1	10.00 254.0	0 - 1.50 0 - 38.1	1.5 38.1	
12 300	200 1375	200 1375	N/R	1	10.00 254.0	0 - 1.50 0 - 38.1	1.5 38.1	
14 350	200 1375	200 1375	N/R	1	10.00 254.0	0 - 1.50 0 - 38.1	1.5 38.1	
16 400	200 1375	200 1375	N/R	1	10.00 254.0	0 - 1.50 0 - 38.1	1.5 38.1	
				2	14.38 365.3	0 - 2.00 0 - 50.8	2.00 50.8	
	300 2065	300 2065	N/R	2	16.38 416.1	0 - 3.00 0 - 76.2	3.00 76.2	
				2	18.38 466.9	0 - 4.00 0 - 101.6	4.00 101.6	
18 450	150 1035	150 1035	N/R	1	10.00 254.0	0 - 1.50 0 - 38.1	1.5 38.1	
				2	14.38 365.3	0 - 2.00 0 - 50.8	2.00 50.8	
	250 1725	250 1725	N/R	2	16.38 416.1	0 - 3.00 0 - 76.2	3.00 76.2	
				2	18.38 466.9	0 - 4.00 0 - 101.6	4.00 101.6	
20 500	150 1035	150 1035	N/R	1	10.00 254.0	0 - 1.50 0 - 38.1	1.5 38.1	
				2	14.38 365.3	0 - 2.00 0 - 50.8	2.00 50.8	
	250 1725	250 1725	N/R	2	16.38 416.1	0 - 3.00 0 - 76.2	3.00 76.2	
				2	18.38 466.9	0 - 4.00 0 - 101.6	4.00 101.6	
24 600	100 690	100 690	N/R	1	10.00 254.0	0 - 1.50 0 - 38.1	1.5 38.1	
				2	14.38 365.3	0 - 2.00 0 - 50.8	2.00 50.8	
	150 1035	150 1035	N/R	2	16.38 416.1	0 - 3.00 0 - 76.2	3.00 76.2	
				2	18.38 466.9	0 - 4.00 0 - 101.6	4.00 101.6	
	300 2065	300 2065	N/R	2	14.38 365.3	0 - 2.00 0 - 50.8	2.00 50.8	
				2	16.38 416.1	0 - 3.00 0 - 76.2	3.00 76.2	
		300 2065	300 2065	N/R	2	18.38 466.9	0 - 4.00 0 - 101.6	4.00 101.6
					2	18.38 466.9	0 - 4.00 0 - 101.6	4.00 101.6

(1) For allowable test or transient pressure, the maximum working pressure may be increased to 1½ times the values shown.

(2) The maximum pipe end separation in the tables also represents the maximum allowable axial pipe movement within the coupling. At maximum pipe end separation, axial pipe movement can only be accommodated in the direction of pipe expansion (pipe ends moving toward each other) within the coupled joint. At no time during operation should the pipe ends exceed the maximum listed values. The temperature of the pipe at time of installation will impact the separation between pipe ends. Consult publication 26.20 or contact Victaulic for details.

Style 231S Non-Restrained Flexible Expansion Coupling

PERFORMANCE

Nominal Pipe Size In./mm	(1)			Body Type	Width (Z) In./mm	(2) Pipe End Separation Min - Max In./mm	Max. Allowable Axial Pipe Movement In./mm
	Maximum Working Pressure psi/kPa Carbon Steel	Maximum Working Pressure psi/kPa Stainless Steel	Maximum Working Pressure psi/kPa Ductile Iron				
30 750	100 690		N/R	2	14.38 365.3	0 - 2.00 0 - 50.8	2.00 50.8
				2	16.38 416.1	0 - 3.00 0 - 76.2	3.00 76.2
				2	18.38 466.9	0 - 4.00 0 - 101.6	4.00 101.6
	300 2065		N/R	2	14.38 365.3	0 - 2.00 0 - 50.8	2.00 50.8
				2	16.38 416.1	0 - 3.00 0 - 76.2	3.00 76.2
				2	18.38 466.9	0 - 4.00 0 - 101.6	4.00 101.6
36 900	75 515		N/R	2	14.38 365.3	0 - 2.00 0 - 50.8	2.00 50.8
				2	16.38 416.1	0 - 3.00 0 - 76.2	3.00 76.2
				2	18.38 466.9	0 - 4.00 0 - 101.6	4.00 101.6
	250 1725		N/R	2	14.38 365.3	0 - 2.00 0 - 50.8	2.00 50.8
				2	16.38 416.1	0 - 3.00 0 - 76.2	3.00 76.2
				2	18.38 466.9	0 - 4.00 0 - 101.6	4.00 101.6
42 1050	50 345		N/R	2	14.38 365.3	0 - 2.00 0 - 50.8	2.00 50.8
				2	16.38 416.1	0 - 3.00 0 - 76.2	3.00 76.2
				2	18.38 466.9	0 - 4.00 0 - 101.6	4.00 101.6
	200 1375		N/R	2	14.38 365.3	0 - 2.00 0 - 50.8	2.00 50.8
				2	16.38 416.1	0 - 3.00 0 - 76.2	3.00 76.2
				2	18.38 466.9	0 - 4.00 0 - 101.6	4.00 101.6
48 1200	50 345		N/R	2	14.38 365.3	0 - 2.00 0 - 50.8	2.00 50.8
				2	16.38 416.1	0 - 3.00 0 - 76.2	3.00 76.2
				2	18.38 466.9	0 - 4.00 0 - 101.6	4.00 101.6
	200 1375		N/R	2	14.38 365.3	0 - 2.00 0 - 50.8	2.00 50.8
				2	16.38 416.1	0 - 3.00 0 - 76.2	3.00 76.2
				2	18.38 466.9	0 - 4.00 0 - 101.6	4.00 101.6

(1) For allowable test or transient pressure, the maximum working pressure may be increased to 1½ times the values shown.

(2) The maximum pipe end separation in the tables also represents the maximum allowable axial pipe movement within the coupling. At maximum pipe end separation, axial pipe movement can only be accommodated in the direction of pipe expansion (pipe ends moving toward each other) within the coupled joint. At no time during operation should the pipe ends exceed the maximum listed values. The temperature of the pipe at time of installation will impact the separation between pipe ends. Consult publication 26.20 or contact Victaulic for details.

Style 231S Non-Restrained Flexible Expansion Coupling

PERFORMANCE

Nominal Pipe Size In./mm	(1)			Body Type	Width (Z) In./mm	(2)		Max. Allowable Axial Pipe Movement In./mm
	Maximum Working Pressure psi/kPa Carbon Steel	Maximum Working Pressure psi/kPa Stainless Steel	Maximum Working Pressure psi/kPa Ductile Iron			Pipe End Separation Min - Max In./mm		
54 1350	25 170	25 170	N/R	2	14.38 365.3	0 - 2.00 0 - 50.8	2.00 50.8	
				2	16.38 416.1	0 - 3.00 0 - 76.2	3.00 76.2	
				2	18.38 466.9	0 - 4.00 0 - 101.6	4.00 101.6	
	175 1200	175 1200	N/R	2	14.38 365.3	0 - 2.00 0 - 50.8	2.00 50.8	
				2	16.38 416.1	0 - 3.00 0 - 76.2	3.00 76.2	
				2	18.38 466.9	0 - 4.00 0 - 101.6	4.00 101.6	
60 1500	25 170	25 170	N/R	2	14.38 365.3	0 - 2.00 0 - 50.8	2.00 50.8	
				2	16.38 416.1	0 - 3.00 0 - 76.2	3.00 76.2	
				2	18.38 466.9	0 - 4.00 0 - 101.6	4.00 101.6	
	150 1035	150 1035	N/R	2	14.38 365.3	0 - 2.00 0 - 50.8	2.00 50.8	
				2	16.38 416.1	0 - 3.00 0 - 76.2	3.00 76.2	
				2	18.38 466.9	0 - 4.00 0 - 101.6	4.00 101.6	
66 1650	150 1035	150 1035	N/R	2	14.38 365.3	0 - 2.00 0 - 50.8	2.00 50.8	
				2	16.38 416.1	0 - 3.00 0 - 76.2	3.00 76.2	
				2	18.38 466.9	0 - 4.00 0 - 101.6	4.00 101.6	
72 1800	125 860	125 860	N/R	2	14.38 365.3	0 - 2.00 0 - 50.8	2.00 50.8	
				2	16.38 416.1	0 - 3.00 0 - 76.2	3.00 76.2	
				2	18.38 466.9	0 - 4.00 0 - 101.6	4.00 101.6	
78 1950	125 860	125 860	N/R	2	14.38 365.3	0 - 2.00 0 - 50.8	2.00 50.8	
				2	16.38 416.1	0 - 3.00 0 - 76.2	3.00 76.2	
				2	18.38 466.9	0 - 4.00 0 - 101.6	4.00 101.6	
84 2100	100 690	100 690	N/R	2	14.38 365.3	0 - 2.00 0 - 50.8	2.00 50.8	
				2	16.38 416.1	0 - 3.00 0 - 76.2	3.00 76.2	
				2	18.38 466.9	0 - 4.00 0 - 101.6	4.00 101.6	
90 2250	100 690	100 690	N/R	2	14.38 365.3	0 - 2.00 0 - 50.8	2.00 50.8	
				2	16.38 416.1	0 - 3.00 0 - 76.2	3.00 76.2	
				2	18.38 466.9	0 - 4.00 0 - 101.6	4.00 101.6	
96 2400	100 690	100 690	N/R	2	14.38 365.3	0 - 2.00 0 - 50.8	2.00 50.8	
				2	16.38 416.1	0 - 3.00 0 - 76.2	3.00 76.2	
				2	18.38 466.9	0 - 4.00 0 - 101.6	4.00 101.6	

(1) For allowable test or transient pressure, the maximum working pressure may be increased to 1½ times the values shown.

(2) The maximum pipe end separation in the tables also represents the maximum allowable axial pipe movement within the coupling. At maximum pipe end separation, axial pipe movement can only be accommodated in the direction of pipe expansion (pipe ends moving toward each other) within the coupled joint. At no time during operation should the pipe ends exceed the maximum listed values. The temperature of the pipe at time of installation will impact the separation between pipe ends. Consult publication 26.20 or contact Victaulic for details.

Style 231S Non-Restrained Flexible Expansion Coupling

RESTRAINT RINGS

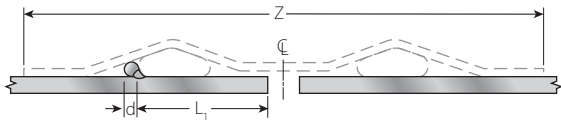

Type 1 - Restraint Ring Location

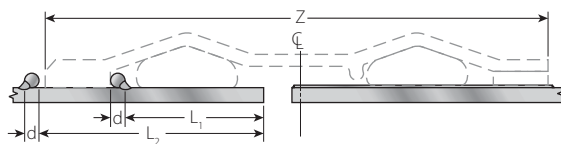

Type 2 - Restraint Ring Location

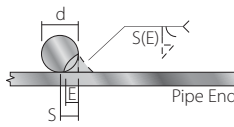

Restraint Ring Single Flare Bevel Groove Weld Detail
Type 1

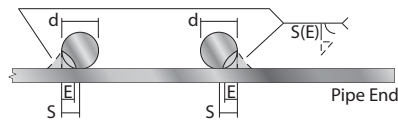

Restraint Ring Single Flare Bevel Groove Weld Detail
Type 2

Nominal Pipe Size In./mm	(1) Maximum Working Pressure psi/kPa	Body Type	Width (Z) In./mm	Restraint Rings								
				Diameter (d) In./mm	(3) Location (L1) In./mm		(3) Weld Size (E) In.					
3 80	300 2065	1	5.25 133.4	1/8	1.25 31.8	—	1/16					
4 100	300 2065	1	5.25 133.4	3/16	1.13 28.6	—	1/16					
6 150	300 2065	1	8.00 203.2	3/16	1.75 44.5	—	1/16					
8 200	200 1375	1	10.00 254.0	1/4	2.00 50.8	—	3/32					
10 250	200 1375	1	10.00 254.0	1/4	2.00 50.8	—	3/32					
12 350	200 1375	1	10.00 254.0	1/4	2.00 50.8	—	3/32					
14 350	200 1375	1	10.00 254.0	1/4	2.00 50.8	—	3/32					
16 400	200 1375	1	10.00 254.0	1/4	2.00 50.8	—	3/32					
								2	14.38 365.3	4.50 114.3	6.25 158.8	3/32
									16.38 416.1	4.50 114.3	6.25 158.8	3/32
18 450	300 2065	2	18.38 466.9	1/4	4.50 114.3	6.25 158.8	3/32					
								1	10.00 254.0	2.00 50.8	—	3/32
									14.38 365.3	4.50 114.3	6.25 158.8	3/32
20 500	300 2065	2	16.38 416.1	1/4	4.50 114.3	6.25 158.8	3/32					
								1	10.00 254.0	2.00 50.8	—	3/32
									14.38 365.3	4.50 114.3	6.25 158.8	3/32
20 500	300 2065	2	18.38 466.9	1/4	4.50 114.3	6.25 158.8	3/32					
								1	10.00 254.0	2.00 50.8	—	3/32
									14.38 365.3	4.50 114.3	6.25 158.8	3/32

- (1) For allowable test or transient pressure, the maximum working pressure may be increased to 1½ times the values shown.
- (2) Restraint rings must be welded perpendicular to the pipe axis with a tolerance of $\pm 1/16$ "/1.6 mm. Each restraint ring shipment includes restraint ring placement and welding data that is specific to application or project requirements. Contact Victaulic for details.
- (3) Flare bevel groove weld size in table is the minimum requirement. Depth of preparation $S = (d) \div 2$; Weld size $E \approx S \times 0.625$ per AWS D1.1. The coupling shoulder must have unrestricted contact with the ring and the pipe O.D.

Note: The data in this table only applies when stainless steel couplings are being used on stainless steel pipe.

Style 231S Non-Restrained Flexible Expansion Coupling

RESTRAINT RINGS

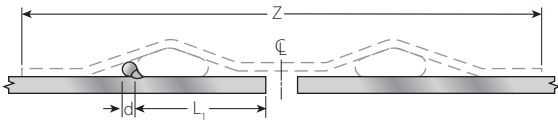

Type 1 - Restraint Ring Location

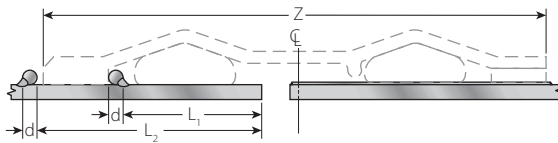

Type 2 - Restraint Ring Location

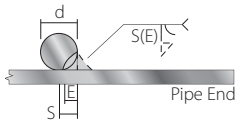

Restraint Ring Single Flare Bevel Groove Weld Detail Type 1

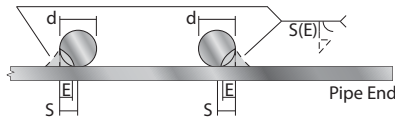

Restraint Ring Single Flare Bevel Groove Weld Detail Type 2

Nominal Pipe Size In./mm	(1) Maximum Working Pressure psi/kPa	Body Type	Width (Z) In./mm	Restraint Rings			
				Diameter (d) In./mm	Location (L1) In./mm	Location (L2) In./mm	(3) Weld Size (E) In.
24 600	100 690	1	10.00 254.0	¼	2.00 50.8	—	¾
			14.38 365.3	¼	4.50 114.3	6.25 158.8	¾
			16.38 416.1	¼	4.50 114.3	6.25 158.8	¾
	150 1035	2	18.38 466.9	¼	4.50 114.3	6.25 158.8	¾
			14.38 365.3	¼	4.50 114.3	6.25 158.8	¾
			16.38 416.1	¼	4.50 114.3	6.25 158.8	¾
30 750	100 690	2	14.38 365.3	¼	4.50 114.3	6.25 158.8	¾
			16.38 416.1	¼	4.50 114.3	6.25 158.8	¾
			18.38 466.9	¼	4.50 114.3	6.25 158.8	¾
	300 2065	2	14.38 365.3	¼	4.50 114.3	6.25 158.8	¾
			16.38 416.1	¼	4.50 114.3	6.25 158.8	¾
			18.38 466.9	¼	4.50 114.3	6.25 158.8	¾
36 900	75 515	2	14.38 365.3	¼	4.50 114.3	6.38 161.9	¾
			16.38 416.1	¼	4.50 114.3	6.38 161.9	¾
			18.38 466.9	¼	4.50 114.3	6.38 161.9	¾
	250 1725	2	14.38 365.3	¼	4.50 114.3	6.38 161.9	¾
			16.38 416.1	¼	4.50 114.3	6.38 161.9	¾
			18.38 466.9	¼	4.50 114.3	6.38 161.9	¾
42 1050	50 345	2	14.38 365.3	¼	4.50 114.3	6.38 161.9	¾
			16.38 416.1	¼	4.50 114.3	6.38 161.9	¾
			18.38 466.9	¼	4.50 114.3	6.38 161.9	¾
	200 1375	2	14.38 365.3	¼	4.50 114.3	6.38 161.9	¾
			16.38 416.1	¼	4.50 114.3	6.38 161.9	¾
			18.38 466.9	¼	4.50 114.3	6.38 161.9	¾

- (1) For allowable test or transient pressure, the maximum working pressure may be increased to 1½ times the values shown.
- (2) Restraint rings must be welded perpendicular to the pipe axis with a tolerance of $\pm \frac{1}{16}$ "/1.6 mm. Each restraint ring shipment includes restraint ring placement and welding data that is specific to application or project requirements. Contact Victaulic for details.
- (3) Flare bevel groove weld size in table is the minimum requirement. Depth of preparation $S = (d) \div 2$; Weld size $E \approx S * 0.625$ per AWS D1.1. The coupling shoulder must have unrestricted contact with the ring and the pipe O.D.

Note: The data in this table only applies when stainless steel couplings are being used on stainless steel pipe.

Style 231S Non-Restrained Flexible Expansion Coupling

RESTRAINT RINGS

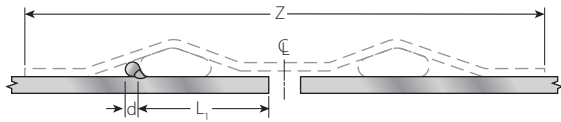

Type 1 - Restraint Ring Location

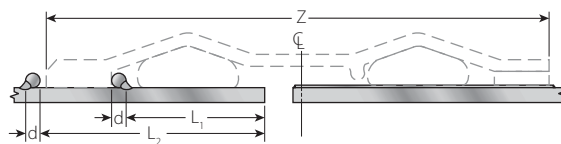

Type 2 - Restraint Ring Location

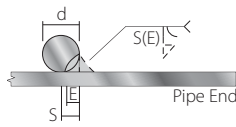

Restraint Ring Single Flare Bevel Groove Weld Detail Type 1

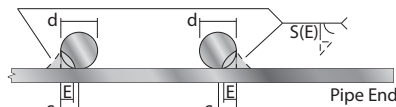

Restraint Ring Single Flare Bevel Groove Weld Detail Type 2

Nominal Pipe Size In./mm	(1) Maximum Working Pressure psi/kPa	Body Type	Width (Z) In./mm	Restraint Rings			
				Diameter (d) In./mm	Location (L1) In./mm	Location (L2) In./mm	Weld Size (E) In.
48 1200	50 345	2	14.38 365.1	1/4	4.50 114.3	6.38 161.9	3/32
			16.38 415.9	1/4	4.50 114.3	6.38 161.9	3/32
			18.38 466.7	1/4	4.50 114.3	6.38 161.9	3/32
	200 1375	2	14.38 365.1	1/4	4.50 114.3	6.38 161.9	3/32
			16.38 415.9	1/4	4.50 114.3	6.38 161.9	3/32
			18.38 466.7	1/4	4.50 114.3	6.38 161.9	3/32
54 1350	25 170	2	14.38 365.1	1/4	4.50 114.3	6.50 165.1	3/32
			16.38 415.9	1/4	4.50 114.3	6.50 165.1	3/32
			18.38 466.7	1/4	4.50 114.3	6.50 165.1	3/32
	175 1200	2	14.38 365.1	1/4	4.50 114.3	6.50 165.1	3/32
			16.38 415.9	1/4	4.50 114.3	6.50 165.1	3/32
			18.38 466.7	1/4	4.50 114.3	6.50 165.1	3/32
60 1500	25 170	2	14.38 365.1	1/4	4.50 114.3	6.50 165.1	3/32
			16.38 415.9	1/4	4.50 114.3	6.50 165.1	3/32
			18.38 466.7	1/4	4.50 114.3	6.50 165.1	3/32
	150 1035	2	14.38 365.1	1/4	4.50 114.3	6.50 165.1	3/32
			16.38 415.9	1/4	4.50 114.3	6.50 165.1	3/32
			18.38 466.7	1/4	4.50 114.3	6.50 165.1	3/32
66 1650	150 1035	2	14.38 365.1	1/4	4.50 114.3	6.50 165.1	3/32
			16.38 415.9	1/4	4.50 114.3	6.50 165.1	3/32
			18.38 466.7	1/4	4.50 114.3	6.50 165.1	3/32
72 1800	125 860	2	14.38 365.1	1/4	4.50 114.3	6.50 165.1	3/32
			16.38 415.9	1/4	4.50 114.3	6.50 165.1	3/32
			18.38 466.7	1/4	4.50 114.3	6.50 165.1	3/32

- (1) For allowable test or transient pressure, the maximum working pressure may be increased to 1½ times the values shown.
- (2) Restraint rings must be welded perpendicular to the pipe axis with a tolerance of $L \pm 1/16" / 1.6$ mm. Each restraint ring shipment includes restraint ring placement and welding data that is specific to application or project requirements. Contact Victaulic for details.
- (3) Flare bevel groove weld size in table is the minimum requirement. Depth of preparation $S = (d) \div 2$; Weld size $E \approx S * 0.625$ per AWS D1.1. The coupling shoulder must have unrestricted contact with the ring and the pipe O.D.

Note: The data in this table only applies when stainless steel couplings are being used on stainless steel pipe.

Style 231S Non-Restrained Flexible Expansion Coupling

RESTRAINT RINGS

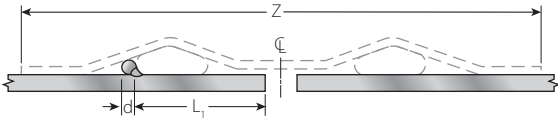

Type 1 - Restraint Ring Location

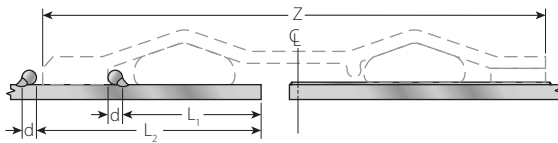

Type 2 - Restraint Ring Location

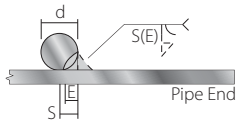

Restraint Ring Single Flare Bevel Groove Weld Detail
Type 1

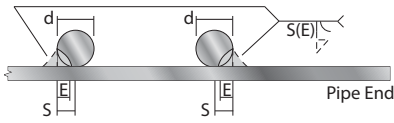

Restraint Ring Single Flare Bevel Groove Weld Detail
Type 2

Nominal Pipe Size In./mm	(1) Maximum Working Pressure psi/kPa	Body Type	Width (Z) In./mm	Restraint Rings			
				Diameter (d) In./mm	Location (L1) In./mm	Location (L2) In./mm	Weld Size (E) In.
78 1950	125 860	2	14.38 365.3	¼	4.50 114.3	6.50 165.1	¾/2
			16.38 416.1	¼	4.50 114.3	6.50 165.1	¾/2
			18.38 466.9	¼	4.50 114.3	6.50 165.1	¾/2
84 2100	100 690	2	14.38 365.3	¼	4.50 114.3	6.50 165.1	¾/2
			16.38 416.1	¼	4.50 114.3	6.50 165.1	¾/2
			18.38 466.9	¼	4.50 114.3	6.50 165.1	¾/2
90 2250	100 690	2	14.38 365.3	¼	4.50 114.3	6.50 165.1	¾/2
			16.38 416.1	¼	4.50 114.3	6.50 165.1	¾/2
			18.38 466.9	¼	4.50 114.3	6.50 165.1	¾/2
96 2400	100 690	2	14.38 365.3	¼	4.50 114.3	6.50 165.1	¾/2
			16.38 416.1	¼	4.50 114.3	6.50 165.1	¾/2
			18.38 466.9	¼	4.50 114.3	6.50 165.1	¾/2

- (1) For allowable test or transient pressure, the maximum working pressure may be increased to 1½ times the values shown.
- (2) Restraint rings must be welded perpendicular to the pipe axis with a tolerance of $\pm 1/16$ "/1.6 mm. Each restraint ring shipment includes restraint ring placement and welding data that is specific to application or project requirements. Contact Victaulic for details.
- (3) Flare bevel groove weld size in table is the minimum requirement. Depth of preparation $S = (d) \div 2$; Weld size $E \approx S * 0.625$ per AWS D1.1. The coupling shoulder must have unrestricted contact with the ring and the pipe O.D.

Note: The data in this table only applies when stainless steel couplings are being used on stainless steel pipe.

Style 231S Non-Restrained Flexible Expansion Coupling

CLOSURE TOOLS



MANUAL TOOL



HYDRAULIC TOOL

Manual Tools

- CTM-01: for use on 5" and 8" body widths
- CTM-02: for use on 10" body widths
for use on 12" body widths with thickness of $\frac{3}{16}$ " or less

Hydraulic Tools

- CTH-01*: for use on 12" body widths with thickness of $\frac{1}{4}$ " or greater
for use on 14", 16" and 18" body widths
- CTH-02: for use on all type 3 couplings

- Hydraulic tool package comes standard with:

- one (1) tool head
- one (1) hydraulic cylinder
- one (1) hydraulic hose
- one (1) hand pump

* A CTH-01 hydraulic closure tool can be used in applications where the CTM-02 manual closure tool is recommended.

Note: The closure tools listed above are designed specifically for Victaulic Style 230, 231, 232 and 233 couplings. If ordering custom product, contact Victaulic for appropriate tool selection.

Style 231S Non-Restrained Flexible Expansion Coupling

PRODUCT CONFIGURATOR

C 0231 0096 50 X 2 C E O X X B

Class	Style	Actual Pipe O.D.*		Body Type	Segments	PSI/kPa Rating	Rubber Compound	Paint	Hardware	Ring Pipe Material	Movement †
		Inches [^]	Fraction								
C	0231	0002 through 0102	00 – 0 13 – 1/8 25 – 1/4 38 – 3/8 50 – 1/2 63 – 5/8 75 – 3/4 88 – 7/8	X – Stainless	1 – One 2 – Two	A – 25/170 B – 50/345 C – 75/515 D – 100/690 E – 125/860 F – 150/1035 G – 175/1200 H – 200/1375 J – 250/1725 K – 300/2065	E – EPDM I – Isoprene L – Silicone T – Nitrile V – Neoprene O – Fluoro-elastomer	0 – None	X – Stainless	X – Stainless Ring on Stainless Steel Pipe S – Carbon Steel Ring on Carbon Steel Pipe D – Carbon Steel Ring on Ductile Iron Pipe	A – 0.75" B – 1.25" C – 1.50" D – 2.00" E – 3.00" F – 4.00"

[^] Couplings are available in a range of nominal sizes from 3 – 96".

* For actual pipe O.D. round down to the nearest 1/8" to determine proper coupling size required.

† Movement provided is dependent on size and body type and must correspond to allowable movements published in the product submittal.

ENGINEERED PRODUCTS OPTIONS

For non-standard products the Victaulic Engineered Products group can assist with specialty joints designed to meet the specific size, pressure and temperature requirements of your system.

WARRANTY

Refer to the Warranty section of the current Price List or contact Victaulic for details.

NOTE

This product shall be manufactured by Victaulic or to Victaulic specifications. All products to be installed in accordance with current Victaulic installation/assembly instructions. Victaulic reserves the right to change product specifications, designs and standard equipment without notice and without incurring obligations.

TESTING

Victaulic Style 231S couplings are designed to allow for a 50 percent increase over the published maximum working pressure for test and/or transient pressures. Due to the huge volume of air that can be involved in jobsite air testing and the nature of air or gas that is pressurized, jobsite air testing should be limited to 25 psi/175 kPa or less.

For complete contact information, visit www.victaulic.com

60.04 3365 REV J UPDATED 08/2013

VICTAULIC IS A REGISTERED TRADEMARK OF VICTAULIC COMPANY. © 2013 VICTAULIC COMPANY. ALL RIGHTS RESERVED.